

ARTIC 900 BT ICE CREAM

Ref: 1



Ref: 2

Temperature range/Range di temperatura -35/-10° C

Doors, drawers/porte, cassetti 1

Refrigerated cabinets with feet or castors made of AISI 304 stainless steel inside and white plastic-coated outside, version 900, with blind doors. Insulation thickness 90 mm. Standard accessories: 20 pairs of L-shaped guides for trays EN400x600 or EN600X800 (PASTRY version), 7 reinforced stainless steel grids EN600X800 (ICE-CREAM version). Models with incorporated or remote unit (Mod. R, without valve), automatic defrosting and evaporation of condensation water (incorporated mod.). Lock and micro door as standard. Optional: LED light .

Armadi refrigerati con piedi o ruote in acciaio inox AISI 304 interno ed esterno in plastificato bianco , versione 900, con porte cieche. Spessore isolamento 90 mm. Accessori di serie: 20 coppie guide a L per vassoi EN400x600 o EN600X800 (versione PASTRY), 7 griglie inox rinforzate EN600X800 (versione ICE-CREAM). Modelli con monoblocco con gruppo incorporato o remoto (Mod. R, senza valvola), sbrinamento ed evaporazione acqua di condensa automatici (mod. incorporati). Serratura e micro porta di serie. Optional: luce LED .

Maximum Shelves N°/ Max Ripiani N°: 24 EN 600x800

Maximum Pans N°/ Max Vaschette N°:

All specifications are subject to change without notice. *Dati tecnici soggetti a modifiche senza preavviso.*

The Picture (Ref: 1), the description (Ref: 2) and the technical drawing (Ref: 5) refer to the product range. Dimensional Data (Ref: 3) and Technical Data (Ref: 4) refer to the specific code (Ref: 6).

L'immagine (Ref: 1), la descrizione (Ref: 2) e il disegno tecnico (Ref: 5) sono relativi alla famiglia prodotto. Dati di dimensione (Ref: 3) e Dati Tecnici (Ref: 4) sono specifici del codice indicato (Ref: 6).

Afinox s.r.l. via Venezia 4 - 35010 - Campo San Martino - Padova (PD) - ITALY - Tel. +39 0499638311 / e-mail: comm@afinox.com / web: www.afinox.com

Ref: 6 Code/Codice 7F090IBC5A002

Pag. 1 / 4

Rev.: 1 / 2024

Dimensional Data/Dati di dimensione:

Ref: 3

External dimensions (mm) WxDxH <i>Dimensioni Esterne (mm) LxPxH</i>	803x1011x2090	Insulation Thickness (mm) <i>Spessore di isolamento (mm)</i>	90
Packing Dimensions (mm) WxDxH <i>Dimensioni Imballo (mm) LxPxH</i>	863x1065x2170	Internal Volume (l) <i>Volume Interno (l)</i>	640
		Gross Weight (Kg) <i>Peso Lordo (Kg)</i>	186
		Net Weight (Kg) <i>Peso Netto (Kg)</i>	141

Technical Data/Dati Tecnici:

Ref: 4

Power supply (V/Ph/Hz) <i>Alimentazione (V/P/Hz)</i>	230 / 1 / 50	Noise (db) 5m <i>Rumore (db) 5m</i>	53
Yearly Energy Consumption (kWh/annum) <i>Consumo energetico Annuo (kWh/annum)</i>	3400	Daily energy consumption (kWh/24h) <i>Consumo energetico 24H (kWh)</i>	8,68
Nominal power consumption (W) <i>Potenza assorbita (W)</i>	526*	Maximum absorbed current (A) <i>Massima corrente assorbita (A)</i>	7,21
Energy efficiency class <i>Classe Energetica</i>	D	Climatic Class <i>Classe Climatica</i>	5 (40°C - 40%)
Blast chilling yield (Kg) *** <i>Resa Abbattimento (Kg) ***</i>		Refrigerating power (W) <i>Potenza Frigorifera (W)</i>	735*
Shock freezing yield (Kg) *** <i>Resa Surgelazione (Kg) ***</i>		Gas	R290 - GWP 3 - Kg 0,15
Compressor/ <i>Compressore</i>		Controller	EV3B
NT2180U			

* (-30/+45° C), **(-10/+45° C) # Hood/Sovrastruttura

*** The blast chilling & shock freezing yields, expressed in Kg or lb are indicative and not binding. The food cooling time depends on its composition and sizing. The actual cooling time for various food might be different from the indicated one.

*** Le rese in abbattimento e in surgelazione espresse in Kg o lb sono indicative e non vincolanti. Il tempo di raffreddamento degli alimenti dipende dalla loro composizione e dimensione. Il tempo di raffreddamento reale dei vari alimenti, potrebbe essere diverso da quello indicato.

All specifications are subject to change without notice. *Dati tecnici soggetti a modifiche senza preavviso.*

The Picture (Ref: 1), the description (Ref: 2) and the technical drawing (Ref: 5) refer to the product range. Dimensional Data (Ref: 3) and Technical Data (Ref: 4) refer to the specific code (Ref: 6).

L'immagine (Ref: 1), la descrizione (Ref: 2) e il disegno tecnico (Ref: 5) sono relativi alla famiglia prodotto. Dati di dimensione (Ref: 3) e Dati Tecnici (Ref: 4) sono specifici del codice indicato (Ref: 6).

Afinox s.r.l. via Venezia 4 - 35010 - Campo San Martino - Padova (PD) - ITALY - Tel. +39 0499638311 / e-mail: comm@afinox.com / web: www.afinox.com

Ref: 6 Code/Codice 7F090IBC5A002

Pag. 2 / 4

Rev.: 1 / 2024

A = ELECTRICAL CONNECTION

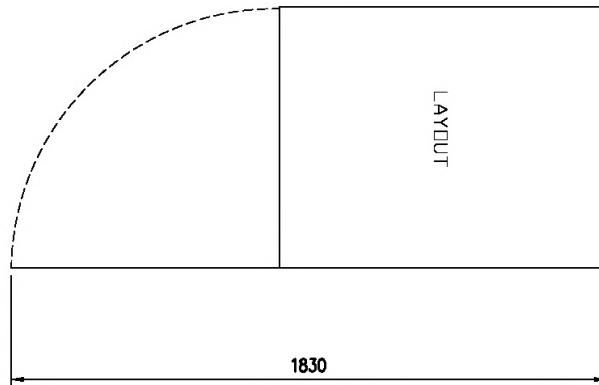
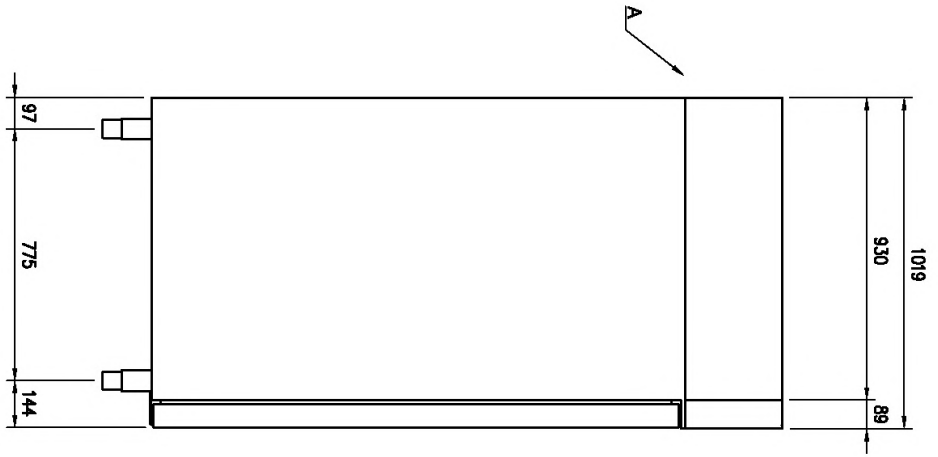
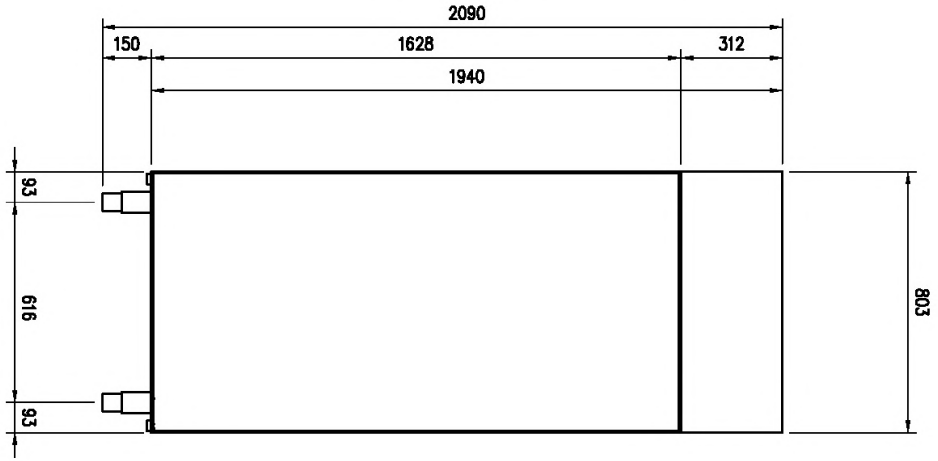

All specifications are subject to change without notice. *Dati tecnici soggetti a modifiche senza preavviso.*

The Picture (Ref: 1), the description (Ref: 2) and the technical drawing (Ref: 5) refer to the product range. Dimensional Data (Ref: 3) and Technical Data (Ref: 4) refer to the specific code (Ref: 6).

L'immagine (Ref: 1), la descrizione (Ref: 2) e il disegno tecnico (Ref: 5) sono relativi alla famiglia prodotto. Dati di dimensione (Ref: 3) e Dati Tecnici (Ref: 4) sono specifici del codice indicato (Ref: 6).

Afinox s.r.l. via Venezia 4 - 35010 - Campo San Martino - Padova (PD) - ITALY - Tel. +39 0499638311 / e-mail: comm@afinox.com / web: www.afinox.com

Ref: 6 Code/Codice 7F090IBC5A002

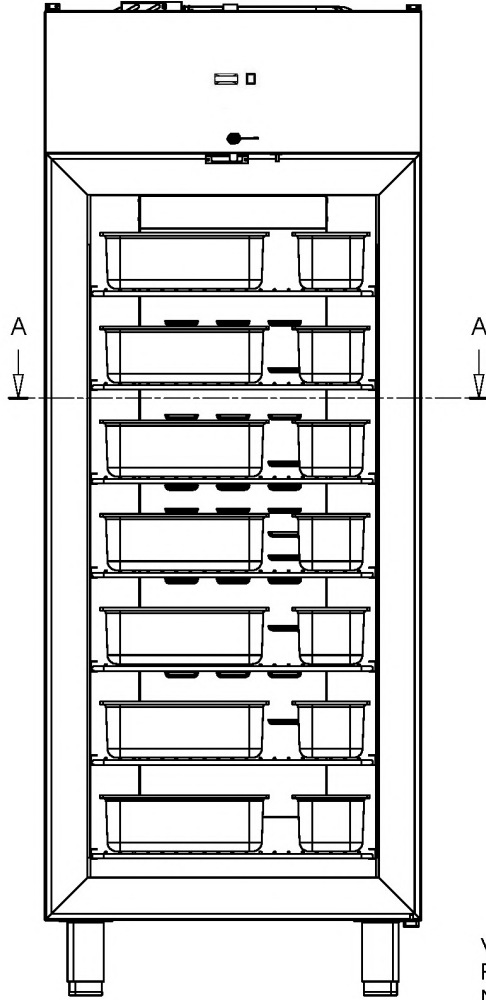



VASCHETTA GELATERIA 165x365x120
 PASSO VASCHETTE 200
 NUEMRO VASCHETTE 49

ICE CREAM PANS 165X365X120
 PITCH OF PANS 200
 NUMBER OF PANS 49

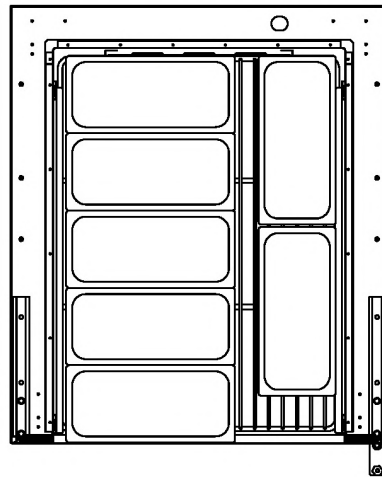
A-A



DISEGNATO: M. Bertan	DATA: 31/01/2018	PROGETTO:	
CONTROLLATO:	QUOTE DI CONTROLLO	DENOMINAZIONE:	
MATERIALE:	SPESORE:	TRATTAMENTO:	

TOLLERANZE GENERALI DIMENSIONI < 150 mm ± 0.5 mm DIMENSIONI > 150 mm ± 1 mm ANGOLI = ± 0.5°

All specifications are subject to change without notice. *Dati tecnici soggetti a modifiche senza preavviso.*

The Picture (Ref: 1), the description (Ref: 2) and the technical drawing (Ref: 5) refer to the product range. Dimensional Data (Ref: 3) and Technical Data (Ref: 4) refer to the specific code (Ref: 6).

L'immagine (Ref: 1), la descrizione (Ref: 2) e il disegno tecnico (Ref: 5) sono relativi alla famiglia prodotto. Dati di dimensione (Ref: 3) e Dati Tecnici (Ref: 4) sono specifici del codice indicato (Ref: 6).

Afinox s.r.l. via Venezia 4 - 35010 - Campo San Martino - Padova (PD) - ITALY - Tel. +39 0499638311 / e-mail: comm@afinox.com / web: www.afinox.com

Ref: 6 Code/Codice 7F090IBC5A002

Pag. 4 / 4

Rev.: 1 / 2024